

or
D



Request for Quotation (RFQ) for Goods

Purchase of equipment for hairdresser and beauty salons in support of women entrepreneurship

RFQ Ref No: UNOPS-EP-2016-G-018

Version: v2016.1

Invitation letter

Dear Sir/Madam,

Subject: Request for Quotations for Purchase of equipment for hairdresser and beauty salons in support of women entrepreneurship in South East and South West Serbia
RFQ Case No.: UNOPS-EP-2016-G-018

The United Nations Office for Project Services (hereinafter referred to as UNOPS) is pleased to invite prospective bidders to submit a quotation for the provision of goods/services in accordance with the UNOPS General Conditions of Contract and the Schedule of Requirements as set out in this Request for Quotation (RFQ).

The RFQ consists of the following:

- This RFQ Invitation Letter
- Section I: RFQ Particulars
- Section II: Instructions to Bidders
- Section III: Schedule of Requirements
- Section IV: Returnable Bidding Forms
 - Form A: Quotation Submission Form
 - Form B: Price Schedule Form
 - Form C: Technical Quotation Form
 - Form D: Previous Experience Form

If you are interested in submitting a quotation in response to this RFQ, please prepare your quotation in accordance with the requirements and process as set out in this RFQ and submit it to UNOPS by the deadline for quotation submission set out in the Section I: RFQ Particulars.

We look forward to receiving your quotation.

Approved by:



Name: Marko Vujacic

Title: European PROGRES National Programme Manager

Date: 05 April 2016

Section I: RFQ Particulars

Scope of Quotation	This RFQ refers to the provision of equipment for hairdresser and beauty salons in support of women entrepreneurship in South East and South West Serbia , as further described in Section III: Schedule of Requirements.
Contact person for correspondence, notifications and requests for clarifications	All correspondence, notifications and requests for clarifications in relation to this RFQ shall be sent to the following e-mail address: srpc.procurement@unops.org United Nations Office for Project Services Republic of Serbia Operations Centre Šumatovačka 59 11000 Belgrade, Serbia ATTENTION: quotations shall not be submitted to the above address but to the address for quotation submission as set out below.
Clarifications	Requests for clarification from bidders will not be accepted by any later than 08 April 2016. Responses to requests for clarification will be communicated at LBHT web site (http://www.sagradimodom.org) and European PROGRES website (www.europeanprogres.org) under RFQ Case UNOPS-EP-2016-G-018 (Public Calls/Tenders).
Quotation validity period	Quotations shall remain valid for acceptance by UNOPS for ninety 90 days for RFQ from the Deadline for Quotation Submission.
Quotation Currenc(ies)	Quotations shall be quoted in RSD (Republic of Serbia Dinars). UNOPS reserves the right not to reject any bids submitted in another currency than the mandatory bidding currency stated above.
Duties and Taxes	All quotations shall be submitted net of any direct taxes, customs duties and indirect taxes and VAT.
Language of quotations	All quotations, information, documents and correspondence exchanged between UNOPS and the Bidders in relation to this RFQ process shall be in English.
Deadline for Quotation Submission	All quotations must be submitted by 12:00, CET on 12 April 2016.
Quotation submission	Quotations must be submitted as follows: Quotation form must be completed signed and returned to UNOPS. The quotations must be made in accordance with the instructions contained in this request. All quotations must be submitted to the following address Address: Šumatovačka 59, 11000 Belgrade, Serbia Or to E-mail: srpc.bids@unops.org Contact person: Suzana Tanaskovic Quotations submitted shall be binding and valid for a period of ninety (90) days from the due date stated herein. Any prices accepted during this period will be considered firm/fixed for the resulting purchase order. The supplier agrees to acknowledge the purchase order in the form provided upon award, under the terms and conditions stated therein, and for the agreed amount.

Evaluation method and criteria	<p>Quotations shall be evaluated to determine the lowest price most technically acceptable offer. Evaluation shall be conducted as follows:</p> <ol style="list-style-type: none"> 1. Preliminary Examination. The following eligibility and formal criteria will be reviewed for compliance: <ul style="list-style-type: none"> • Bidder is eligible as defined in Instructions to Bidders, Article 3 • Completeness of the Quotation. All Returnable Bidding Forms and other documentation requested have been provided and are complete • Bidder accepts UNOPS General Conditions of Contract 2. Qualifications of the Bidder will be assessed as per below qualification criteria: <ul style="list-style-type: none"> • Bidder should be in continuous business of supplying equipment for hairdresser and beauty salons for the last 3 (three) years. • Bidder must also identify and disclose all information regarding any related entity/s, if any, by providing full legal name and address of the related entity/s. Should there be no related entities, the Bidder must provide a statement to that effect. 3. Technical compliance of the offered goods/services. The following technical criteria will be reviewed for compliance compared to UNOPS requirements: <ul style="list-style-type: none"> • Goods/services offered in the quotation are compliant compared to the requirements in Section III: Schedule of Requirements. 4. Financial evaluation. Quotations that are found to be technically acceptable shall be evaluated based on price and UNOPS will award the contract as per the lowest priced, most technically acceptable offer evaluation methodology. <p>At any time during the evaluation process UNOPS may request clarification or further information in writing from Bidders. The Bidder's responses shall not contain any changes regarding the substance, including the technical and financial part of their quotation. UNOPS may use such information in interpreting and evaluating the relevant quotation.</p>
Partial quotations	<p>Bidders shall be allowed to quote prices for one or more items identified in Section III: Schedule of Requirements, however Bidders must offer 100% of the quantities specified for each item. Evaluation will be done per item.</p>
Documents comprising the Quotation	<p>Bidders shall include the following documents in their quotation:</p> <ul style="list-style-type: none"> • Form A: Quotation Submission Form • Form B: Price Schedule Form • Form C: Technical Quotation Form • Form D: Previous Experience Form • Registration, financial and legal documents: <ul style="list-style-type: none"> - Document from Business Registers Agency not older than 6 months; • Previous experience (references): <ul style="list-style-type: none"> - Minimum three contracts and/or valid invoices proving the successful delivery of equipment for hairdresser and beauty salons, in the last three years, in support of the information given in the Previous Experience Form • Catalogue, brochure or similar document that will prove the required characteristics of the offered goods.
Type of Contract to be awarded	<p>UNOPS will sign the following contract with the awarded Bidder(s): Purchase Order</p>

General Conditions of Contract	<p>In the event of an order, the following conditions of contract will apply: UNOPS General Conditions of Contract for goods</p> <p>The conditions are available at: http://www.unops.org/english/Opportunities/suppliers/how-we-procure/Pages/default.aspx</p>
Signing of Contract	UNOPS plans to award the Contract by 20 April 2016 .
UNGM registration	<p>Any Contract resulting from this RFQ exercise will be subject to the supplier registration on United Nations Global Marketplace (UNGM) website. Vendors can register their company by accessing the website at www.ungm.org.</p> <p>The Bidder may still submit a quotation even if not registered with the UNGM, however, if the Bidder is selected for Contract award, the Bidder must register on the UNGM prior to Contract signature</p>

Section II: Instructions to Bidders

1. SCOPE OF QUOTATION

Bidders are invited to submit a quotation for the goods and/or services specified in Section III: Schedule of Requirements, in accordance with this RFQ.

2. INTERPRETATION OF THE RFQ

This RFQ is an invitation to treat and shall not be construed as an offer capable of being accepted or as creating any contractual, other legal or restitutionary rights.

This RFQ is conducted in accordance with the applicable provisions of UNOPS Procurement Manual (latest version of which can be accessed at: <https://www.unops.org/english/Opportunities/suppliers/how-we-procure/Pages/default.aspx>) and other relevant Organisational Directives and Administrative Instructions that are referred to in the Procurement Manual. In case of contradictions between this RFQ and the UNOPS Procurement Manual, the UNOPS Procurement Manual shall prevail.

3. BIDDER ELIGIBILITY

Bidders may be a private, public or government-owned legal entity or any association with legal capacity to enter into a binding Contract with UNOPS.

A Bidder shall not be eligible to submit a quotation if and when at the time of quotation submission, the Bidder:

- i. is included in the Ineligibility List, hosted by UNGM, that aggregates information disclosed by UNOPS (UNOPS Ineligibility List) and other Agencies, Funds or Programs of the UN System;
- ii. is included in UN/PD's suspended and removed vendors list;
- iii. is included in the Consolidated United Nations Security Council Sanctions List, including the UN Security Council Resolution 1267/1989 list;
- iv. is included in the World Bank Corporate Procurement Listing of Non-Responsible Vendors and World Bank Listing of Ineligible Firms and Individuals;

All Bidders are expected to embrace the principles of the United Nations Supplier Code of Conduct, given that it originates from the core values of the Charter of the United Nations. UNOPS also expects all its suppliers to adhere to the principles of the United Nations Global Compact.

4. CLARIFICATION OF THE RFQ

Bidders may request clarification in relation to the RFQ or bid process by submitting a written request to the contact stated in the **Section I: RFQ Particulars**, until the time stated in **Section I: RFQ Particulars**. Explanations or interpretations provided by personnel other than the named contact person, will not be considered binding or official.

5. REMUNERATION FOR AND COSTS OF QUOTATIONS

Bidders shall not be entitled to any remuneration or compensation for the preparation and submission of their quotation.

6. QUOTATION CURRENC(IES)

The quotation shall be made in the currenc(ies) stated in **Section I: RFQ Particulars**. If applicable, for comparison and evaluation purposes, UNOPS will convert the quotations into USD at the official United Nations rate of exchange in force at the time of the deadline for quotation Submission.

UNOPS reserves the right not to reject any quotation submitted in a currency other than the mandatory bidding currenc(ies). UNOPS may accept quotations submitted in another currency than stated above if the Bidder confirms during clarification of quotations in writing that it will accept a Contract issued in the mandatory quotation currency and that for conversion the official United Nations operational rate of exchange of the day of RFQ deadline as stated in Section I: RFQ Particulars shall apply. Regardless of the currency of quotations received, the Contract will always be issued and subsequent payments will be made in the mandatory bidding currency above.

Rates in quotations shall be fixed. Quotations with adjustable rates shall be disqualified.

7. DUTIES AND TAXES

Article II, Section 7, of the Convention on the Privileges and Immunities provides, inter alia, that the United Nations, including UNOPS as a subsidiary organ, is exempt from all direct taxes, except charges for public utility services, and is exempt from customs restrictions, duties, and charges of a similar nature in respect of articles imported or exported for its official use. All quotations shall be submitted net of any direct taxes and any other taxes and duties, unless otherwise specified in **Section I: RFQ Particulars**.

8. PAYMENT TERMS

UNOPS will ordinarily effect payment within 30 days after receipt of the goods/services and on submission of payment documentation. Time in connection with discounts offered for accelerated payment will be computed from the date of receipt of payment documents by UNOPS. Payment discounts will not be considered in the financial evaluation.

9. PUBLICATION OF CONTRACT AWARD

UNOPS shall publish in its website (<https://data.unops.org>) information regarding the purchase order(s) awarded as a result of this RFQ.

10. ETHICS AND PROSCRIBED PRACTICES

UNOPS requires that all Bidders observe the highest standard of ethics during the entire RFQ process, as well as the duration of any Contract that may be signed as a result of this process. Therefore, all Bidders shall represent and warrant that they:

- (i) have not unduly obtained, or attempted to unduly obtain, any confidential information in connection with the RFQ process and any Contract that may be signed as a result of this RFQ process;
- (ii) have no conflict of interest that would prevent them from entering into a Contract with UNOPS, and shall have no interest in other parties involved in this RFQ process or in the project underlying this RFQ process;
- (iii) have not engaged, or attempted to engage, in any Proscribed Practices in connection with this RFQ process or the Contract that may be awarded as a result of this RFQ process. For the purposes of this provision, Proscribed Practices are defined in the UNOPS Vendor Sanctions Procedures, and include: corrupt practice, fraudulent practice, coercive practice, collusive practice, unethical practice and obstruction.

11. AUDIT

UNOPS may conduct investigations relating to any aspect of the Contract award at any time during the term of the Contract and for a period of three (3) years following the expiration or prior termination of the Contract. The Contractor shall provide its full and timely cooperation with any such inspections, post-payment audits or investigations. Such cooperation shall include, but shall not be limited to, the Contractor's obligation to make available its personnel and any relevant documentation for such purposes at reasonable times and on reasonable conditions and to grant to UNOPS access to the Contractor's premises at reasonable times and on reasonable conditions in connection with such access to the Contractor's personnel and relevant documentation. The Contractor shall require its agents, including, but not limited to, the Contractor's attorneys, accountants or other advisers, to reasonably cooperate with any inspections, post-payment audits or investigations carried out by UNOPS hereunder.

12. BID PROTEST

Any Bidder that believes to have been unjustly treated in connection with this RFQ process or any Contract that may be awarded as a result of such RFQ process may submit a complaint to UNOPS' General Counsel. More information about bid protests can be found on UNOPS' website at www.unops.org.

Section III: Schedule of Requirements

List of goods & quantities:

LOT I – Equipment for hairdresser salons

Item No	List of goods	Quantity
1.	Ceramic Shampoo Chair I	1
2.	Ceramic Shampoo Chair II	3
3.	Footrest per one hairstyling place	2
4.	Armchair	2
5.	Hairdressers Hydraulic Chair I	2
6.	Hairdressers Hydraulic Chair II	2
7.	Hairdressing Trolley	1
8.	Hairdressing Counter	2
9.	Make-up Chair	1
10.	Sofa I	1
11.	Sofa II	1
12.	Set of professional Hot Rollers I	1
13.	Set of Professional Hot Rollers II	1
14.	Hairdryer	7
15.	Curling Iron 3 in 1	2
16.	Tourmaline Curler	1
17.	Five Barrel Curler	1
18.	Curling Iron with Motor	1
19.	Hood dryer	1
20.	Thinning Shears	3

21.	Razor-Edge Scissors	3
22.	Micro-Tech Scissors	3
23.	Hair Clippers	4
24.	Flat Iron 1	2
25.	Flat Iron 2	1
26.	Flat Iron 3	1
27.	Sterilizer	1
28.	Practice Head	1

LOT II –Equipment for beauty salons

Item No	List of goods	Quantity
1.	Electrically adjustable cosmetics bed	3
2.	Cosmetics bed	2
3.	Makeup Chair, High Chair	4
4.	Auxiliary Cosmetics Trolley without Drawers	3
5.	Auxilliary Cosmetics Trolley with Shelving and Drawers	5
6.	Auxilliary Cosmetic Chair	3
7.	Manicure Table	2
8.	Pedicure Chair	1
9.	Massage Oil Heating Device	1
10.	Manicure Table Draft Fan	1
11.	Manicure Extractor Fan (table mount)	2
12.	Electric Nail File	5
13.	Stone Heater	1
14.	Pedicure Tub	3

15.	Combined Wax Warmer	3
16.	Professional Cosmetics Case	1
17.	Nail Drying LED Lamp	1
18.	Magnifying Glass With Light	1
19.	Manicure - Handrest with Dust Collector	1
20.	Nail Trainer	1
21.	Hot/Cold Nail Polish Dryer	1
22.	Dry-Heat Steriliser	1
23.	Paraffin Melter, Aluminium	2
24.	Double Hot Wax Warmer	1
25.	Hot Wax Warmer	1
26.	Trio Wax Cartridge Heater with Base	1
27.	UV Lamp	2
28.	UV lamp with Fan	1
29.	UV LED Nail Lamp	2
30.	Volcanic stone set	2
31.	Multifunctional Device I	1
32.	Multifunctional Device II	1
33.	Interference Current Device	1
34.	Magnetic Therapy Device	1
35.	Mesotherapy Device	1
36.	Diamond Tip Microdermoabrasion Device	1
37.	Ultrasound cavitation device	1
38.	Aqua detox	1

39.	Electro stimulator	1
40.	Multifunctional Beauty Instrument	1
41.	Cosmetics Device	1
42.	Multifunctional Beauty Device	1
43.	Multifunctional Device	1
44.	Tanning booth tower	1
45.	Tanning booth vertical - tower	1
46.	Tens stimulator	1
47.	Physical Therapy Ultrasound	1

NOTE: The offered equipment must comply with requirements laid down in the Technical specifications (Form C: Technical Quotation Form - Technical specifications for goods – Comparative Data Table). The required specifications present minimum requirements. Bidders may offer items with more advanced specs and such offers are accepted as appropriate.

Manufacturer's technical literature submitted with the offer must comply with the written specifications of the Bidder. In the event that there are differences between the submitted manufacturers' literature and written Bidder specification reasons for that must be explained in the Bidder specifications. Manufacturer's technical literature (brochures, booklets, instructions, etc.) should be submitted. The manufacturers' technical literature should be marked in an appropriate manner (i.e. model number).

Bidder warrants that offered equipment is new and unused. Bidder shall further warrant that none of the supplies have any defect arising from design, materials or workmanship.

Where applicable, items must be in compliance with the Law on health safety of products for general use Republic of Serbia.

The Contractor will be responsible for providing after sales support through the standard manufacturer's warranty, which cannot be less than one year.

Quotations per LOT are allowed.

Section IV: Returnable Bidding Forms

Note to Bidders: Instructions to complete each Form are highlighted in blue in each Form. Please complete the Returnable Bidding Forms as instructed and return them as part of your quotation.

The following returnable forms are part of this RFQ and must be completed and returned by bidders as part of their Quotation.

Form A: Quotation submission form

Bidders are requested to complete this form, sign it and return it as part of their bid submission. The bidder shall fill in this form in accordance with the instructions indicated. No alterations to its format shall be permitted and no substitutions shall be accepted.

Date: [Insert submission date] _____

Subject: Quotation for the supply of [insert a brief description of goods/services] in _____ [Name of country/city],
RFQ Case No. [insert RFQ ref number] _____, dated [insert date] _____.

We, the undersigned, declare that:

- a. We offer to supply in conformity with the bidding documents, including the UNOPS General Conditions of Contract.
- b. Our quotation shall be valid for the period of time of [insert number of days which shall not be less than the specified in Section I: Bid Particulars, Period of Validity of Bids] _____ from the date fixed for the bid submission deadline as set out in the RFQ, and it shall remain binding upon us and may be accepted at any time before the expiration of that period;
- c. We have no conflict of interest in any activity that would put it, if selected for this assignment, in a conflict of interest with UNOPS;
- d. Our firm confirms that the offeror and sub-contractors have not been associated, or had been involved in any way, directly or indirectly, with the preparation of the design, terms of references and/or other documents used as a part of this solicitation;
- e. Our firm, its affiliates or subsidiaries—including any subcontractors or suppliers for any part of the Contract—has not been declared ineligible by UNOPS, nor is included in the suspended/ineligibility list of the UN/DP, other UN Agencies, the UN Security Council, and the World Bank, in accordance with Instructions to Bidders Article 3, Eligibility;
- f. We embrace the UN Supplier Code of Conduct and adhere to the principles of the UN Global Compact
- g. We have not declared bankruptcy, are not involved in bankruptcy or receivership proceedings, and there is no judgment or pending legal action against them that could impair their operations in the foreseeable future.
- h. We have not offered and will not offer fees, gifts and/or favours of kind in exchange for this RFQ and will not engage in any such activity during the performance of any Contract awarded.

I, the undersigned, certify that I am duly authorized by [insert full name of bidder] _____ to sign this quotation and bind [insert full name of bidder] should

UNOPS accept this quotation:

Name: [complete] _____

Title: [complete] _____

Signature: _____

Provide the name and contact information for the primary contact from your company for this quotation:

Name: [complete] _____

Title: [complete] _____

Email address: [complete] _____

Telephone: [complete] _____

Form B: Price Schedule Form

Bidders shall fill in this Price Schedule Form in accordance with the instructions indicated.

RFQ reference no: [insert RFQ reference No.]

LOT I – Equipment for hairdresser salons

Currency	RSD
----------	-----

Item No	Description	Qty	Unit price DAP Tax free in RSD	Total price DAP Tax free in RSD
1.	Ceramic Shampoo Chair I	1		
2.	Ceramic Shampoo Chair II	3		
3.	Footrest per one hairstyling place	2		
4.	Armchair	2		
5.	Hairdressers Hydraulic Chair I	2		
6.	Hairdressers Hydraulic Chair II	2		
7.	Hairdressing Trolley	1		
8.	Hairdressing Counter	2		
9.	Make-up Chair	1		
10.	Sofa I	1		
11.	Sofa II	1		
12.	Set of professional Hot Rollers I	1		
13.	Set of Professional Hot Rollers II	1		
14.	Hairdryer	7		
15.	Curling Iron 3 in 1	2		
16.	Tourmaline Curler	1		
17.	Five Barrel Curler	1		

18.	Curling Iron with Motor	1		
19.	Hood dryer	1		
20.	Thinning Shears	3		
21.	Razor-Edge Scissors	3		
22.	Micro-Tech Scissors	3		
23.	Hair Clippers	4		
24.	Flat Iron 1	2		
25.	Flat Iron 2	1		
26.	Flat Iron 3	1		
27.	Sterilizer	1		
28.	Practice Head	1		
TOTAL PRICE LOT I				(Insert)

LOT II – Equipment for beauty salons

Item No	Description	Qty	Unit price DAP Tax free in RSD	Total price DAP Tax free in RSD
1.	Electrically adjustable cosmetics bed	3		
2.	Cosmetics bed	2		
3.	Makeup Chair, High Chair	4		
4.	Auxiliary Cosmetics Trolley without Drawers	3		
5.	Auxilliary Cosmetics Trolley with Shelving and Drawers	5		
6.	Auxilliary Cosmetic Chair	3		
7.	Manicure Table	2		

8.	Pedicure Chair	1		
9.	Massage Oil Heating Device	1		
10.	Manicure Table Draft Fan	1		
11.	Manicure Extractor Fan (table mount)	2		
12.	Electric Nail File	5		
13.	Stone Heater	1		
14.	Pedicure Tub	3		
15.	Combined Wax Warmer	3		
16.	Professional Cosmetics Case	1		
17.	Nail Drying LED Lamp	1		
18.	Magnifying Glass With Light	1		
19.	Manicure - Handrest with Dust Collector	1		
20.	Nail Trainer	1		
21.	Hot/Cold Nail Polish Dryer	1		
22.	Dry-Heat Steriliser	1		
23.	Paraffin Melter, Aluminium	2		
24.	Double Hot Wax Warmer	1		
25.	Hot Wax Warmer	1		
26.	Trio Wax Cartridge Heater with Base	1		
27.	UV Lamp	2		
28.	UV lamp with Fan	1		

29.	UV LED Nail Lamp	2		
30.	Volcanic stone set	2		
31.	Multifunctional Device I	1		
32.	Multifunctional Device II	1		
33.	Interference Current Device	1		
34.	Magnetic Therapy Device	1		
35.	Mesotherapy Device	1		
36.	Diamond Tip Microdermoabrasion Device	1		
37.	Ultrasound cavitation device	1		
38.	Aqua detox	1		
39.	Electro stimulator	1		
40.	Multifunctional Beauty Instrument	1		
41.	Cosmetics Device	1		
42.	Multifunctional Beauty Device	1		
43.	Multifunctional Device	1		
44.	Tanning booth tower	1		
45.	Tanning booth vertical - tower	1		
46.	Tens stimulator	1		
47.	Physical Therapy Ultrasound	1		
TOTAL PRICE LOT II				(Insert)

Payment terms 30 days accepted: Yes

Bidder's discount for accelerated payment: _____% of total firm price for each calendar day less than thirty (30) days

List of subcontractors or suppliers

Bidder must identify the names of all subcontractors/suppliers who will be providing good/services under this Contract and the type of work being subcontracted, if applicable.

[Full legal name and address of subcontractors]

(A) _____

(B) _____

(C) _____

I, the undersigned, certify that I am duly authorized by [*insert full name of Bidder*]

_____ to sign this quotation and bind

_____ [*insert full name of Bidder*] should UNOPS accept this quotation:

Name : _____

Title : _____

Date : _____

Signature : _____

Form C: Technical Quotation Form



RFQ reference no: [insert RFQ reference No.] _____



Name of Bidder: [insert name of Bidder] _____

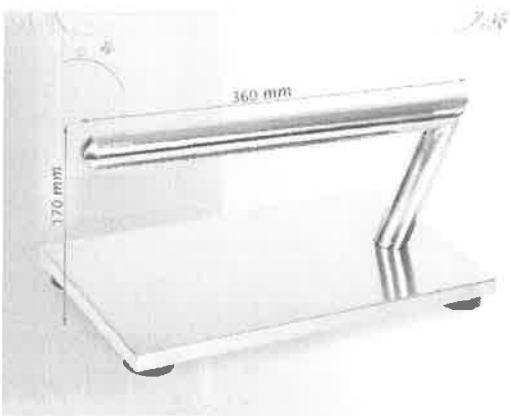

Bidders are required to complete the **Comparative Data Tables** included in Section III: Schedule of Requirements to demonstrate compliance with UNOPS requirements and insert them below. Bidders are NOT allowed to make any change in the "UNOPS requirements" columns of the Comparative Data Tables. Such changes might disqualify your quotation.

Technical specifications for goods – Comparative Data Table

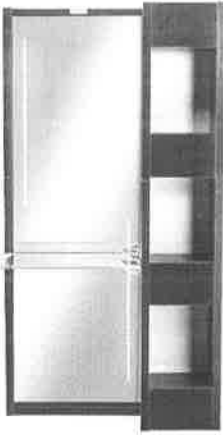

Item No	UNOPS minimum technical requirements	Qty	Is quotation compliant? Bidder to complete	Details of goods offered. Bidder to complete Insert details of goods offered, including specifications and brand/model offered if applicable
1.	Ceramic Shampoo Chair I Height: 800 - 950 mm Length: 900- 1500 mm Width: 600-800 mm Water supply: from the back and the floor Water drainage: from the back and the floor Adjustable ceramic slope Stability: floor installation Ceramic colour: white Chair colour: white	1	<input type="checkbox"/> Yes <input type="checkbox"/> No	
2.	Ceramic Shampoo Chair II Height: minimum 1000 mm Length: minimum 1000 mm Width: minimum 500 mm Water supply: floor and back Water drainage: floor and back Adjustable ceramic slope Stability Floor installation Chair colour: black	3	<input type="checkbox"/> Yes <input type="checkbox"/> No	
3.	Footrest per one hairstyling place Metal base Placed under hairdressing counter (workplace), similar to the picture below: 	2	<input type="checkbox"/> Yes <input type="checkbox"/> No	

4.	<p>Armchair Colour: black Material: synthetic leather, similar to the picture below:</p> 	2	<input type="checkbox"/> Yes <input type="checkbox"/> No	
5.	<p>Hairdressers Hydraulic Chair I Seat colour: white Material: synthetic leather Base colour: chrome Max. seat height: 730 mm Min. seat height: 500 mm Seat width: 500-700 mm Hydraulic capacity: 120 kg minimum, similar to the picture below</p> 	2	<input type="checkbox"/> Yes <input type="checkbox"/> No	
6.	<p>Hairdressers Hydraulic Chair II Universal (unisex) chair Seat colour: black Material: synthetic leather Base colour: chrome</p>	2	<input type="checkbox"/> Yes <input type="checkbox"/> No	

	<p>Max. seat height: 730 mm Min. seat height: 500 mm Seat width: 500-700 mm Hydraulic capacity: 120 kg minimum Foot rest, similar to the picture below:</p> 			
<p>7.</p>	<p>Hairdressing Trolley Colour: white 5 - 10 shelves Metal frame Metal hairdryer holder, similar to the picture below:</p> 	<p>1</p>	<p><input type="checkbox"/> Yes <input type="checkbox"/> No</p>	
<p>8.</p>	<p>Hairdressing Counter Mirror with a shelf and light per one hairstyling place Colour: MDF colour or burgundy, or black or yellow-black Power: 80W minimum, similar to the picture</p>	<p>2</p>	<p><input type="checkbox"/> Yes <input type="checkbox"/> No</p>	

	<p>below:</p> 			
9.	<p>Make-up Chair Foldable, similar to the picture below:</p> 	1	<input type="checkbox"/> Yes <input type="checkbox"/> No	
10.	<p>Sofa I Colour: white Material: synthetic leather Sofa height: 600-800 mm Seat height: 300-400 mm Backrest height: 300-400 mm Sofa width: 1200- 1600 mm, similar to the picture below:</p> 	1	<input type="checkbox"/> Yes <input type="checkbox"/> No	
11.	<p>Sofa II Colour: black</p>	1	<input type="checkbox"/> Yes <input type="checkbox"/> No	

	Material: synthetic leather Sofa height: maximum 800 mm Seat height: minimum 300 mm Backrest height: minimum 300 mm Sofa width: minimum 1200 mm Armrests and backrests			
12.	Set of Professional Hot Rollers I 9 different size rollers Ion technology, fast heating 2 extra large rollers (50mm) 7 large rollers (38mm) 13 fixing needles + 4 spare 9 clips"	1	<input type="checkbox"/> Yes <input type="checkbox"/> No	
13.	Set of Professional Hot Rollers II 20 different size rollers Ion technology, fast heating 8 large rollers (28mm) 6 medium rollers (25mm) 6 small rollers (22mm) 20 fixing needles + 6 spare 10 clips	1	<input type="checkbox"/> Yes <input type="checkbox"/> No	
14.	Hairdryer Air speed: minimum 75km/h Ion technology: minimum 70,000,000 ions/cm3 AC motor Power 2000-2200W Maximum temperature 110°C Air speed: maximum 110m3/h 4 temperature settings 2 speed settings Ceramic - tourmaline grid Two air deflectors Conical grid for hair styling Cord length: minimum 2m	7	<input type="checkbox"/> Yes <input type="checkbox"/> No	
15.	3-in-1 Curling Iron 3 appliances in one Styling iron for curls Styling iron for waves Styling iron for spiral curls Magnetic accessories Minimum temperature range between 160-200°C, Smooth ceramic Argan oil coated barrels, Auto shut-off, Cable length minimum 3m, Heat resistant storing pouch Heat resistant glove	2	<input type="checkbox"/> Yes <input type="checkbox"/> No	
16.	Tourmaline Curler Ceramic, 25 -18 mm, similar to the picture	1	<input type="checkbox"/> Yes <input type="checkbox"/> No	

	 <p>below:</p>			
<p>17.</p>	<p>Five Barrel Curler 5 interchangeable barrels different in size and an extension for lifting hair roots Infrared technology from 60°C to 220°C Ion technology Material: titanium Similar to the picture below</p> 	<p>1</p>	<p><input type="checkbox"/> Yes <input type="checkbox"/> No</p>	
<p>18.</p>	<p>Curling Iron with Motor 10-15 possible temperature settings ranging from minimum 70 to maximum 220°C Automatic shut-off Cable length minimum 3m Heat resistant storing pouch Heat resistant gloves</p>	<p>1</p>	<p><input type="checkbox"/> Yes <input type="checkbox"/> No</p>	
<p>19.</p>	<p>Hood Dryer Two speed Minimum power :1100 W Work mode: 230V, 50Hz Preferred color: black Similar to the picture below</p> 	<p>1</p>	<p><input type="checkbox"/> Yes <input type="checkbox"/> No</p>	

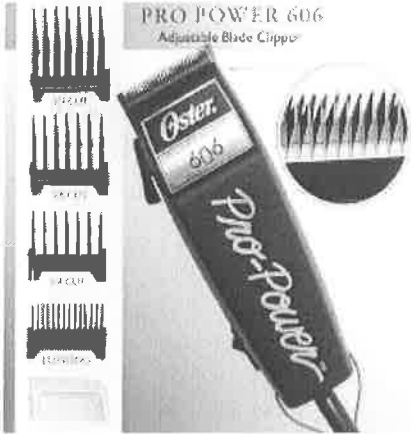

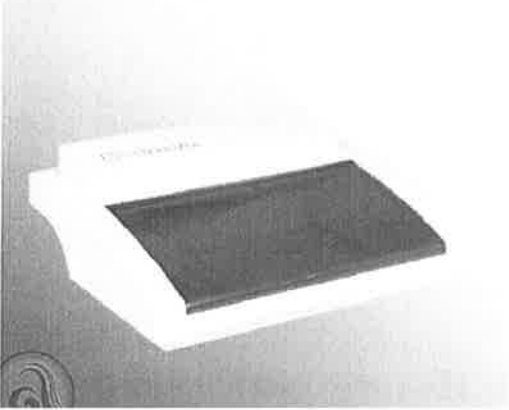

20.	Thinning Shears Diamond sharpened blade Stainless steel Size 5.5" (14cm) 38 teeth blade	3	<input type="checkbox"/> Yes <input type="checkbox"/> No	
21.	Razor-Edge Scissors Self-sharpening blade Material: carbon reinforced 440C steel Size: 5.5" (14cm) Blade: convex razor sharp blade Finger rest	3	<input type="checkbox"/> Yes <input type="checkbox"/> No	
22.	Micro-Tech Scissors Diamond sharpened blade Stainless steel Size: 5.5" (14 cm) Blade: micro-tech (for straight hair cutting)	3	<input type="checkbox"/> Yes <input type="checkbox"/> No	
23.	Hair Clippers Manual adjustment from 0.1 mm to 3 mm. Set includes: hair clippers, blade protector, 4-6 additional combs, lubricating oil, cleaning brush Mode: 230 V, 50 Hz, minimum 9 W Similar to the picture below 	4	<input type="checkbox"/> Yes <input type="checkbox"/> No	
24.	Flat Iron 1 Thermal technology Macadamia oil, Argan oil and keratin coated ceramic plates Heats up to 110°C in 7-10 sec Heats up to 180°C in 15-20 sec Digital temperature setting range between 110-230°C Similar to the picture below	2	<input type="checkbox"/> Yes <input type="checkbox"/> No	



				
25.	Flat Iron 2 Ceramic tourmaline plates generate infrared rays and ions Heats up in 30 sec	1	<input type="checkbox"/> Yes <input type="checkbox"/> No	
26.	Flat Iron 3 Argan oil coated ceramic floating plates Heats up to 110°C in 10 seconds Heats up to 180°C in 30 seconds	1	<input type="checkbox"/> Yes <input type="checkbox"/> No	
27.	Sterilizer Lamp power minimum 8 W Sterilization time 30-45 min Can sterilize hair accessories and pedicure-manicure accessories Similar to the picture below 	1	<input type="checkbox"/> Yes <input type="checkbox"/> No	
28.	Practice Head (with Natural Hair) Hair length 50 - 60 cm Each strand of hair stitched by hand	1	<input type="checkbox"/> Yes <input type="checkbox"/> No	



LOT II –Equipment for beauty salons



Technical specifications for goods – Comparative Data Table

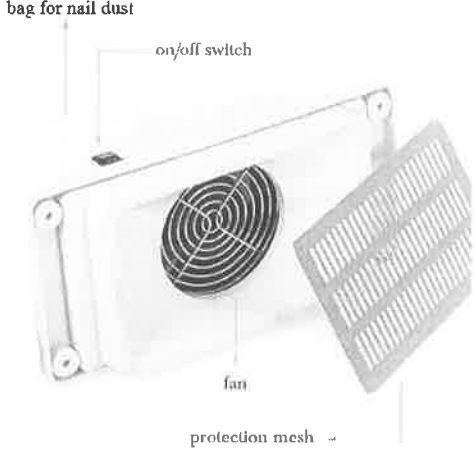

Item No	UNOPS minimum technical requirements	Qty	Is quotation compliant? Bidder to complete	Details of goods offered. Bidder to complete Insert details of goods offered, including specifications and brand/model offered if applicable
1.	<p>Electrically adjustable cosmetics bed Total length: flat 1800-2040mm, Width: 700-850mm Seat height: 650-850mm Backrest: 720-860mm Weight: 50-60kg Bed Colour: white Upholstery: synthetic leather Electric height adjustment Electric backrest and foot rest adjustment Face rest with added cushion</p>	3	<input type="checkbox"/> Yes <input type="checkbox"/> No	
2.	<p>Cosmetic bed Length 1800-1900mm Width 550-750mm Height 700-800mm Weight 20/25kg Load Bearing Capacity 180-250kg Upholstery Colour White Upholstery Synthetic Leather Face rest with added cushion Added shelf under bed Adjustable backrest Similar to the picture below</p> 	2	<input type="checkbox"/> Yes <input type="checkbox"/> No	
3.	<p>Makeup Chair High Chair, Load bearing capacity up to 150kg Chair weight: 6-8 kg Colour: white With backrest Minimum seat height: 45 cm Maximum seat height: 80 cm Minimum backrest height: 75 cm Minimum backrest height: 110 cm Padding: minimum 10cm delux cushion Upholstery: PVC</p>	4	<input type="checkbox"/> Yes <input type="checkbox"/> No	



	Similar to the picture below 			
4.	Auxiliary Cosmetics Trolley Without drawers, min. 4 shelves Similar to the picture below 	3	<input type="checkbox"/> Yes <input type="checkbox"/> No	
5.	Auxiliary Cosmetics Trolley Minimum 4 shelves, minimum 2 drawers Similar to the picture below 	5	<input type="checkbox"/> Yes <input type="checkbox"/> No	
6.	Auxiliary Cosmetic Chair With or without backrest, gas pump, height adjustment, max height 600mm - 800 mm, min height 400 mm, Colour: white Similar to the picture below: 	3	<input type="checkbox"/> Yes <input type="checkbox"/> No	
7.	Manicure Table Portable table with a wheel base 2 separate elements, colour: white 6 drawer minimum Similar to the picture below:	2	<input type="checkbox"/> Yes <input type="checkbox"/> No	



				
8.	<p>Pedicure Chair Dimensions (LxHxW), minimum 100x50x50cm, Adjustable height, Colour: white, Upholstery: synthetic leather Foot rest, fixed or height adjustable Similar to the picture below:</p> 	1	<input type="checkbox"/> Yes <input type="checkbox"/> No	
9.	<p>Massage Oil Heating Device Oil/lotion/cream heating, automatic heating system, min 40W, 25 minutes maximum needed to heat massage oil, additional massage oil bottle</p>	1	<input type="checkbox"/> Yes <input type="checkbox"/> No	
10.	<p>Manicure Table Draft Fan Mountable manicure table draft fan with appropriate bag for dust collection Power: 25 W minimum Similar to the picture below:</p> 	1	<input type="checkbox"/> Yes <input type="checkbox"/> No	
11.	<p>Manicure Extractor Fan (table mount) Operating at 220V; 50HZ; power: 25W minimum, Colour: white, table mount Similar to the picture below</p>	2	<input type="checkbox"/> Yes <input type="checkbox"/> No	

				
12.	<p>Electric Nail File Filing bits 6 pcs (2 coarse, 2 medium coarse, 2 fine), Diamond bits 4-6 pcs, Filing ring 5-7 pcs, Filing ring bit 1, Twist lock bit changing system, Rpm minimum 28000 /min, Voltage 220-230V, Frequency 50/60Hz, Power minimum 30W, Output power control Rotation direction change switch Speed adjustable during operation Similar to the picture below:</p> 	5	<input type="checkbox"/> Yes <input type="checkbox"/> No	
13.	<p>Stone Heater Dimensions (HxWxL) minimum 35x25x15cm Capacity: minimum 6 lit, Temperature adjustment option, Operating at (power and voltage) minimum 700 W, 220-240V Handles for safe transportation of unheated stones.</p>	1	<input type="checkbox"/> Yes <input type="checkbox"/> No	
14.	<p>Pedicure Tub Capacity 8 litres minimum, Operating mode 220V-240V, 50HZ, Power 350 W minimum Water heating 35°C minimum, 3D foot massage, IR -infrared function, O3- ozone sterilisation, Jacuzzi system, Minimum 50 foot area massaging points, Rotating ball foot massagers, Pedicure pumice stone, Anti-slip, Weight 5kg maximum</p>	3	<input type="checkbox"/> Yes <input type="checkbox"/> No	
15.	<p>Combined Wax Warmer Volume: minimum 800 ml + 3 mono 2-6 wax cartridges for cold wax 1 hot wax tin, dimensions temperature range minimum 40°C - maximum 110°C</p>	3	<input type="checkbox"/> Yes <input type="checkbox"/> No	

16.	<p>Professional Cosmetics Case Cosmetics case, foldable, minimum 22x36x25cm Similar to the picture below</p> 	1	<input type="checkbox"/> Yes <input type="checkbox"/> No	
17.	<p>Nail Drying LED Lamp Power: minimum 15 - maximum 40W Digital display, Drying time Timer: minimum 5 - maximum 100 sec, 5 finger drying, Constant operation: from 1s to 90s, Removable bottom, LED diodes, Heat resistant casing, Sensor on- and off-switch Similar to the picture below:</p> 	1	<input type="checkbox"/> Yes <input type="checkbox"/> No	
18.	<p>Magnifying Glass With Light Voltage: 220V/50Hz, Power: 22W function Large magnifier - 4 x minimum Small magnifier glass - 10 x minimum Similar to the picture below:</p> 	1	<input type="checkbox"/> Yes <input type="checkbox"/> No	
19.	<p>Manicure – Hand rest with Dust Collector Desirable but not obligatory colour - black Operating at 220-240V, 50HZ; fan power 25 W maximum</p>	1	<input type="checkbox"/> Yes <input type="checkbox"/> No	
20.	<p>Nail Trainer Hand with flexible long arm. The hand serves for training and education and to master the manufacture of artificial nails in various forms. Bendable and including a finger position adjustment option. Similar to the picture below:</p>	1	<input type="checkbox"/> Yes <input type="checkbox"/> No	

				
21.	Hot/Cold Nail Polish Dryer Operating at 220/240V;50/60Hz	1	<input type="checkbox"/> Yes <input type="checkbox"/> No	
22.	Dry-Heat Steriliser Casing metal, voltage 220V 50/60Hz, power/consumption 250W minimum, weight 6 kg maximum, intended for sterilising metal and glassware in temperatures up to 250°C, automatic temperature control Similar to the picture below: 	1	<input type="checkbox"/> Yes <input type="checkbox"/> No	
23.	Paraffin Melter, Aluminium Dish for paraffin melting made of aluminium, Operating at 220-240V, 50HZ, power - 150W minimum - 400W maximum, Paraffin heating time 180 minutes maximum. Brush for paraffin application. Similar to the picture below: 	2	<input type="checkbox"/> Yes <input type="checkbox"/> No	
24.	Double Hot Wax Warmer Capacity 6 kg minimum, Operating at 220-240V, 50HZ, power 400W minimum Adjustable temperature, Stainless steel filter, 1-2 temperature control thermostats temperature control up to 120°C Similar to the picture below:	1	<input type="checkbox"/> Yes <input type="checkbox"/> No	

				
25.	<p>Hot Wax Warmer Capacity 400g, Operating at 50/60HZ; 220/240V, Power 70 W minimum</p>	1	<input type="checkbox"/> Yes <input type="checkbox"/> No	
26.	<p>Trio Wax Cartridge Heater with Base Purpose: this device is intended for cold waxing, Cartridge size: 100ml, Number of cartridges: 3, Power indicator Operating at 50/60HZ; 110/230V Similar to the picture below:</p> 	1	<input type="checkbox"/> Yes <input type="checkbox"/> No	
27.	<p>UV Lamp Power: 35W minimum, Operating at: 230V, 50/60 Hz, 3 timer settings: 120sec/180sec/constant operation Option to simultaneously dry polish and UV gel</p>	2	<input type="checkbox"/> Yes <input type="checkbox"/> No	
28.	<p>UV lamp with Fan Operating at 230V, 50/60Hz, Power 30W minimum, Timer: 2, 3, 4, minutes with option to to extend time to 5, 6, 7 minutes, Individual functions light indicator Option to simultaneously dry polish and UV gel on 2 hands, UV lamp</p>	1	<input type="checkbox"/> Yes <input type="checkbox"/> No	
29.	<p>UV LED Nail Lamp UV lamp power 32W (4x8W) minimum LED lamp power 14W minimum Operating at 230V, 50/60Hz</p>	2	<input type="checkbox"/> Yes <input type="checkbox"/> No	
30.	<p>Volcanic Stone set Set of minimum 45 volcanic stones Similar to the picture below:</p>	2	<input type="checkbox"/> Yes <input type="checkbox"/> No	

				
31.	<p>3 in 1 Multifunctional Device Microdermabrasion, Ultrasound Waves and Hot&Cold Massage, MICRODERMABRASION Microdermabrasion is peeling off the surface layer of the epidermis and simultaneous stimulation of circulation and lymphatic drainage. ULTRASOUND - Ultrasonic 1. Uses deep penetration of the 1,000,000 Hz ultrasonic wave to provide a gentle and imperceptible tissue massage, simultaneously stimulating blood circulation and the metabolism. Furthermore, cell activity is restored and nutrient elements are more easily absorbed. 2. Assists in cell rejuvenation and quicker release of toxins, making the skin younger and more beautiful. 3. Accelerates the process of removing fat from the body, i.e. its faster burning. HOT/COLD TREATMENT: Swelling reduction, erythema removal, pain reduction, fatty tissue regulation. Cold massage cools the skin, removes red marks, calms the skin, soothes the pain. Massage in linear or circular motion. Hot massage helps in product absorption, accelerates blood and lymph circulation, quickens cell metabolism and activates skin surface metabolism. Similar to the picture below:</p> 	1	<input type="checkbox"/> Yes <input type="checkbox"/> No	
32.	<p>5 in 1 Device Spray, Vacuum, High Frequency, Peeling, Galvanic Current, Spray: applying lotion, tonic and serum with deep spraying into the skin. Vacuum: Massage, squeezing out and vacuuming skin flaws, wrinkle removal, increasing skin elasticity, fat deposit retrogression, a gentle lifting effect. High frequency: Electrotherapy, skin sterilisation and disinfection.</p>	1	<input type="checkbox"/> Yes <input type="checkbox"/> No	



	<p>Skin peeling: Cleaning and massaging the surface of the skin.</p> <p>Jonos-Galvanic Current: positive and negative voltage functions. Depending on the polarity it can achieve natural penetration of elements into the tissue, balancing out acids and bases with the acceleration of blood circulation and the metabolism.</p> <p>Similar to the picture below:</p> 			
33.	<p>Interference Current Device Voltage: 220 V, 50-60 Hz, Electricity consumption/power: 40 W minimum, Output frequency 1000 Hz - 4000 Hz, Electrodes 4 silicone - 8 silicone, 2 independent channels, Intensity adjustment, Timer with shut-off function, LED diode indicator</p>	1	<input type="checkbox"/> Yes <input type="checkbox"/> No	
34.	<p>Magnetic Therapy Device Voltage: 220 V, 50-60 Hz, Electricity consumption/power: 25 W minimum, Output frequency 27,124MHz, Output voltage L(5mT) minimum and H(10mT) minimum 2 independent channels, 2 magnetic strips 2 magnetic blankets, Light detector of magnetic field interruption, LED diode indicator</p>	1	<input type="checkbox"/> Yes <input type="checkbox"/> No	
35.	<p>Mesotherapy Device Voltage: 230 V, 50-60Hz, Electricity consumption/power: 10 W minimum Phial input speed adjustment Treatment duration adjustment Number of therapeutic tips: 2-4pcs Microprocessor controlled, Soft-touch commands, Sound alarm</p>	1	<input type="checkbox"/> Yes <input type="checkbox"/> No	
36.	<p>Diamond Tip Microdermoabrasion Device 8-10 diamond tips of various sizes and grain sizes, Serbian language software, LCD screen, variable vacuum suction power stainless steel handles</p>	1	<input type="checkbox"/> Yes <input type="checkbox"/> No	

				
37.	<p>Ultrasound cavitation device Voltage: 230 V, 50-60 Hz, Electricity consumption/power: 10 w minimum, operating frequency: 28-170 kHz Operating modes: 2 programs - 6 programs With or without electro-stimulation Therapy duration adjustment Number of therapeutic tips: 1 -2kom Microprocessor controlled, Soft-touch commands, Sound alarm</p>	1	<input type="checkbox"/> Yes <input type="checkbox"/> No	
38.	<p>Aqua detox Voltage: 230 V, 50-60 Hz, Electricity consumption/power: 25W minimum Maximum input current 2A, Maximum output voltage 2V - 6V, Soft-touch commands Sound alarm, Microprocessor controlled device, Microprocessor time indicator Microprocessor sensor for presence of person, Digital automatic programs not less than 5, Program switcher</p>	1	<input type="checkbox"/> Yes <input type="checkbox"/> No	
39.	<p>Electro stimulator Voltage: 230 V, 50-60 Hz, Electricity consumption/power: 10W minimum, Signal frequency 10-150Hz, Number of electrodes 24 silicone or aluminium minimum Number of channels not less than 12 Microprocessor controlled, LED on/off indicator, Relaxation settings, Programs not less than 4, Timer 10-60min</p>	1	<input type="checkbox"/> Yes <input type="checkbox"/> No	
40.	<p>14 in 1 Multifunctional Beauty Instrument Vacuum: Massage, squeezing out and vacuuming skin flaws, wrinkle removal, increasing skin elasticity, fat deposit retrogression, a gentle lifting effect. Spray: applying lotion, tonic and serum with deep spraying into the skin. High frequency: Electro therapy, skin sterilisation and disinfection. Spot remover: removing spots, freckles, age spots and scars made by unprofessional squeezing out of acne. Jonos-Galvanic Current: positive and negative voltage functions. Depending on the polarity it can achieve natural penetration of elements into the tissue, balancing out acids and bases with the acceleration of blood circulation and the metabolism. Skin peeling: Cleaning and massaging the surface of the skin. Hot&Cold Treatment: Swelling reduction, erythema removal, fatty tissue regulation.</p>	1	<input type="checkbox"/> Yes <input type="checkbox"/> No	

	<p>Ultrasound: Detailed explanation of this function provided with DMX-2025 device Vapozone: Ozone and aromatherapy. Three steam settings. Massage: Special massaging part (vacuum vibrating balls), increasing skin elasticity, cellulite reduction and stretch mark removal. Wood's lamp: Skin analysis Loupe: minimum 3x magnifying glass Similar to the picture below:</p> 			
<p>41.</p>	<p>3 in 1 Cosmetics Device 3 in 1 device: high frequency, loupe, vapozone Treatments: 1. Facial Steam Treatment 2. Ozone sterilisation 3. Electrotherapy Vapozone is a device that sprays steam. Demineralised water is exclusively use, heated and turned into steam. Ozone is mixed with the steam, ionizing it. Ionized steam the device makes gently stimulates the skin, accelerates blood circulation and metabolism, hydrates the skin and makes it fresh and elastic. Its application in cosmetics is in preparing the face for a thorough cleaning, achieving deep disinfection of the skin, opening pores and deoiling (oily and combination) skin. Similar to the picture below:</p>	<p>1</p>	<p><input type="checkbox"/> Yes <input type="checkbox"/> No</p>	

h

				
42.	<p>17 in 1 Multifunctional Beauty Device Functions: - Magnifying loupe - Hot towel cabinet - High frequency / facial brush - Facial Scrub / Gloves - Spot Removal / Hot&Cold Massage - Galvanic Current / Ultrasonic Skin Scrubber - Wood's Lamp Skin Analyser Add-ons with the machine and all of its functions: Vacuum/ Spray / Microdermoabrasion: - Vacuum/Spray add-ons - Microdermoabrasion High Frequency / Face Brush: - High frequenncy add-ons - Face Brushes Skin Scrubber/ Glove: - Scrubber - add-ons - Glove Spot Removal / Hot&Cold Massage: - Spot removal - add-ons - Hot&cold massage Galvanic Current / Ultrasound: - Galvanic current - Ultrasound Wood's Skin Analysis Lamp Steriliser and UV Towel Heater Similar to the picture below:</p>	1	<input type="checkbox"/> Yes <input type="checkbox"/> No	

				
<p>43.</p>	<p>Multifunctional Device Purpose: Professional beautifying device equipped with a computer program focusing on critical points in weight reduction, body shaping and chest strengthening. Programs: Weight reduction, body shaping and chest strengthening programs, Number of rubber patches: Not less than 16, Number of self-adhesive patches: Not less than 16 (large and small self-adhesive electrodes included), Self-adhesive Elastic Straps Elastic straps for attaching rubber conducting patches Elastic straps of various sizes split into two groups. The first group includes strips for the abdomen, waist, thighs, calves and hands. The second group includes belt-shapes strips used on the chest. Program selection display, Not less than 8 preset programs.</p> 	<p>1</p>	<p><input type="checkbox"/> Yes <input type="checkbox"/> No</p>	



44.	Tanning Booth Tower Body lamps / power not less than 45 / 180 W minimum, Body lamps in the upper shelf, Body lamps in the lower shelf, Face lamps Electronic dimmers, Power 8-kW/h minimum Ventilation duct 200 mm minimum, MP3 Speakers	1	<input type="checkbox"/> Yes <input type="checkbox"/> No	
45.	Tanning Booth Vertical Tower vibration plate, body lamps not less than 48, lamp power 120W minimum, electricity consumption 10 kW minimum, three-phase power source, digital timer	1	<input type="checkbox"/> Yes <input type="checkbox"/> No	
46.	Tens Stimulator Voltage 220 V, 50-60 Hz, Electrical Consumption/power 5W minimum, 2-4 independent channels, Electrodes not less than 4 electrodes, output frequency 10 Hz minimum, Intensity adjustment, modulation adjustment, End of stimulation sound alarm, Timer digital	1	<input type="checkbox"/> Yes <input type="checkbox"/> No	
47.	Physical Therapy Ultrasound Voltage: 230 V, 50-60 Hz, Electrical consumption/power 5 W minimum, Ultrasound frequency 1 and 3 MHz, Modulation impulse, Ultrasound wave intensity 0.5 W/cm ² , times with shut-off function, number of ultrasound tips - 1 pcs multi frequency, microprocessor controlled, LED power indicator	1	<input type="checkbox"/> Yes <input type="checkbox"/> No	

Delivery requirements — Comparative Data Table

UNOPS Requirements		Is quotation compliant? Bidder to complete	Details Bidder to complete Insert details
Delivery time	Bidder shall deliver the goods 20 (twenty) calendar days after Contract signature.	<input type="checkbox"/> Yes <input type="checkbox"/> No	
Delivery place and Incoterms rules	<p>DAP (Delivered at Place) as per Incoterms 2010.</p> <p>Delivery, offload and installation of the equipment on the beneficiaries' premises are included in the price.</p> <p>Beneficiaries are placed in the municipalities of Novi Pazar, Priboj, Nova Varos, Zitoradja and Vranje.</p> <p>Net of any direct taxes, customs duties and indirect taxes and VAT.</p>	<input type="checkbox"/> Yes <input type="checkbox"/> No	
Consignee details	The exact address the goods should be delivered and offloaded to, as well as all other relevant details, will be available upon contract signature.	<input type="checkbox"/> Yes <input type="checkbox"/> No	
UNOPS Right to vary requirements	At the time the Contract is awarded, UNOPS reserves the right to vary the quantity of the goods and associated services specified above, provided this does not exceed +/- 20%, without any change in the unit prices or other terms and conditions of the RFQ.	<input type="checkbox"/> Yes <input type="checkbox"/> No	

The offered goods and related services (if applicable) are in accordance with the required specifications and requirements specified in **Section III: Schedule of Requirements**.

Yes No

ANY DEVIATION MUST BE LISTED BELOW:

Name : _____

Title : _____

Date : _____

Signature : _____

Form D: Previous experience form

RFQ reference no: [insert RFQ reference No.] _____

Name of Bidder: [insert name of Bidder] _____

Description of services/goods	Country	Total amount of Contract	Contract Identification and Title and Contact details of Client: (Name, Address, telephone, email, fax)	Year project was undertaken

Name : _____

Title : _____

Date : _____

Signature : _____

